

Options: Gauge

Magnehelic Gauges

Measures Blower Pressure, Filter Resistance and Room Pressure Drop

Magnehelic Gages

Model No.	Description
803999	.5" Magnehelic Gauge (Gauge Only)
804000	1.0" Magnehelic Gauge (Gauge Only)
804010	2.0" Magnehelic Gauge (Gauge Only)

Static Pressure Chart

For Room Static Pressure	0 to + .25
For Prefilter Resistance	0 to + .5
For HEPA Filter Resistance	0 to + 2.0

Flush Mounted Gauge

Model No.	Description
19802	2.0" Magnehelic Gauge (*Mounted Flush in Housing)

* See Locations A, C, or E.

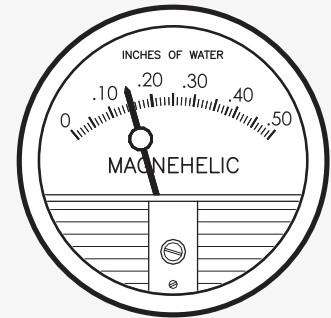

.5" Model No. 803999

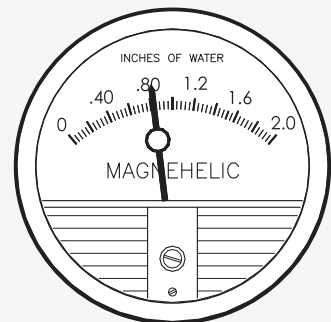

2.0" Model No. 804010

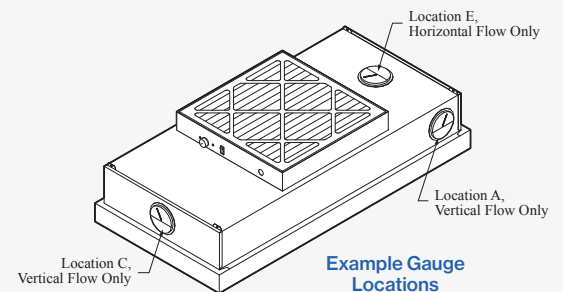

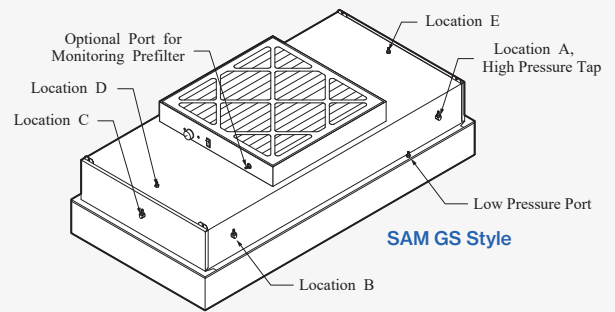
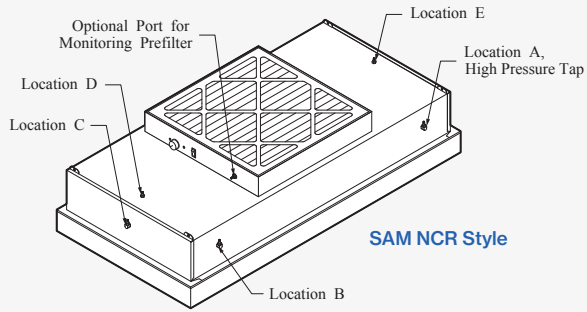

Ports Installed In Housing (For Remote Gauge)

Model No.	Description
19801	2.0" Magnehelic Gauge (*Including Ports in Housing)
19803	(1) Port Only, Magnehelic Gauge Supplied By Others

* Choice of Several Locations See A, B, C, D, or E Above.

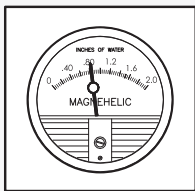

Option "A-A"



Option "A-B"



Option "B"

Multiple locations are possible.
"A-A"/"A-B" designate orientation

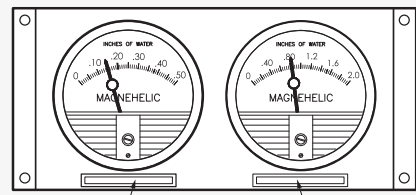

Dual Magnehelic Gauges measure
prefilter and HEPA/ULPA filter
resistance.

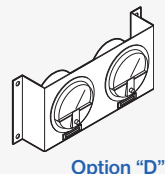

Option "D"

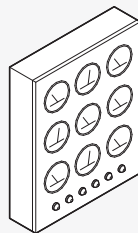
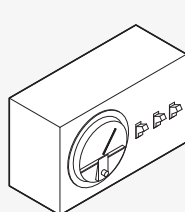
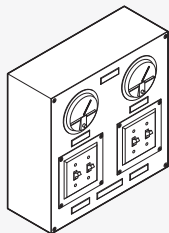

Examples of CRI Surface
Mounted Control Panels

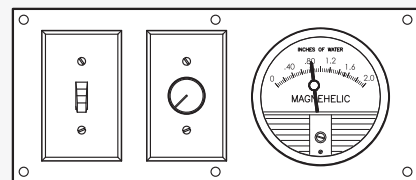

Magnehelic Gauge is surface mounted on
a flat control panel with On/Off switch and
variable speed control.



Option "C"

