

# Work Surfaces and Bench Options

## Perforated SS Work Surfaces

Part No.	Description
19101	SS Work Surface 24" D for 2 Ft Clean Bench
19102	SS Work Surface 24" D for 4 Ft Clean Bench
19103	SS Work Surface 24" D for 6 Ft Clean Bench
19104	SS Work Surface 24" D for 8 Ft Clean Bench
19105	SS Work Surface 32" D for 2 Ft Clean Bench
19106	SS Work Surface 32" D for 4 Ft Clean Bench
19107	SS Work Surface 32" D for 6 Ft Clean Bench
19108	SS Work Surface 32" D for 8 Ft Clean Bench

## Stainless Steel Work Surfaces

Part No.	Description
19109	SS Work Surface 24" D for 2 Ft Clean Bench
19110	SS Work Surface 24" D for 4 Ft Clean Bench
19111	SS Work Surface 24" D for 6 Ft Clean Bench
19112	SS Work Surface 24" D for 8 Ft Clean Bench
19113	SS Work Surface 32" D for 2 Ft Clean Bench
19114	SS Work Surface 32" D for 4 Ft Clean Bench
19115	SS Work Surface 32" D for 6 Ft Clean Bench
19116	SS Work Surface 32" D for 8 Ft Clean Bench

## Caster Option

Part No.	Description
805083	Caster, 3" with Brakes, (4) req'd.

## Static Control Package

Part No.	Description
19754	2' models, 115V, 60Hz
19755	2' models, 208-230V, 50/60Hz
19750	4' models, 115V, 60Hz
19751	4' models, 208-230V, 50/60Hz
19752	6' models, 115V, 60Hz
19753	6' models, 208-230V, 50/60Hz
19756	8' models, 115V, 60Hz
19757	8' models, 208-230V, 50/60Hz

## Duct Collar Adapters

Part No.	Description
19950	10" Duct Collar Adapter
19951	12" Duct Collar Adapter
19952	Side Load Prefilter Frame with 10" Duct Collar Adapter
19953	Side Load Prefilter Frame with 12" Duct Collar Adapter

NOTE: (2) required for SAM 26 Models

## Additional Options

208-230V, 50/60 hz motor	230V, 50 hz lighting for export models
277V, 60 hz motor	ULPA Filter 99.9995% efficiency @ 0.12 micron or larger

## Casters

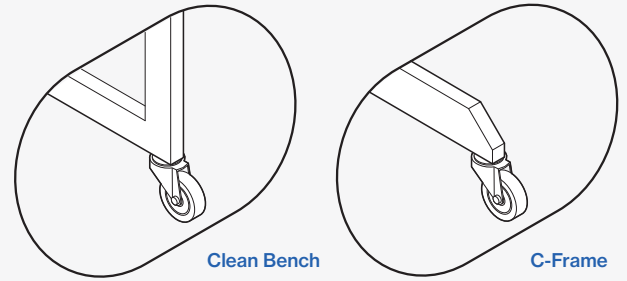

Clean Bench

C-Frame

## Static Control Package

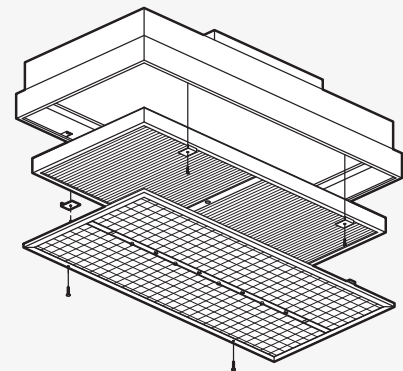

Static Pulse Box Controller is pre-wired and installed in 4ft, GS unit

## Duct Collar Adapters

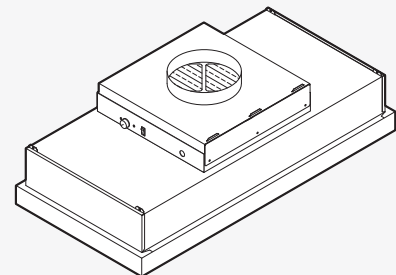
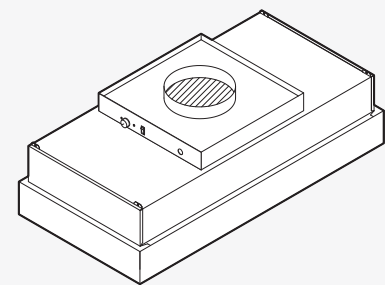

## Front Face Shields

Part No.	Description
905230	Acrylic Face Shield for 2 Ft Bench
905231	Acrylic Face Shield for 4 Ft Bench
905232	Acrylic Face Shield for 6 Ft Bench
905233	Acrylic Face Shield for 8 Ft Bench

## Top Shroud (Vertical Flow)

Part No.	Description
19140	Top Shroud Unit 24" D for 2 Ft Clean Bench
19141	Top Shroud Unit 24" D for 4 Ft Clean Bench
19142	Top Shroud Unit 24" D for 6 Ft Clean Bench
19143	Top Shroud Unit 24" D for 8 Ft Clean Bench
19144	Top Shroud Unit 32" D for 2 Ft Clean Bench
19145	Top Shroud Unit 32" D for 4 Ft Clean Bench
19146	Top Shroud Unit 32" D for 6 Ft Clean Bench
19147	Top Shroud Unit 32" D for 8 Ft Clean Bench

## Top Shroud (Horizontal Flow)

Part No.	Description
19148	Top Shroud Unit 24" D for 2 Ft Clean Bench
19149	Top Shroud Unit 24" D for 4 Ft Clean Bench
19150	Top Shroud Unit 24" D for 6 Ft Clean Bench
19151	Top Shroud Unit 24" D for 8 Ft Clean Bench
19152	Top Shroud Unit 32" D for 2 Ft Clean Bench
19153	Top Shroud Unit 32" D for 4 Ft Clean Bench
19154	Top Shroud Unit 32" D for 6 Ft Clean Bench
19155	Top Shroud Unit 32" D for 8 Ft Clean Bench

## Front Face Shields

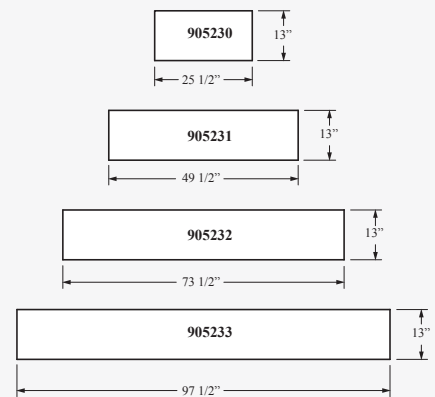
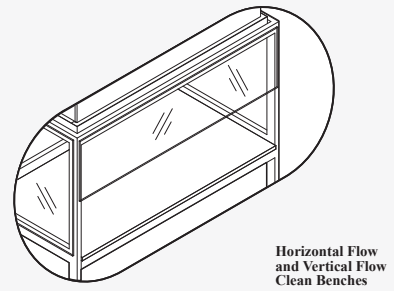
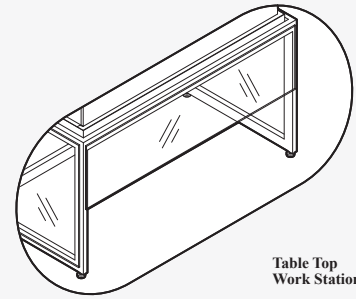

## Top Shroud

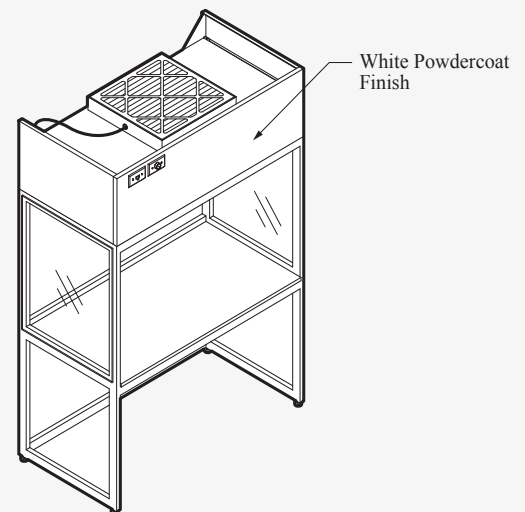

Top Shrouds are available for enclosing the SAM unit. Easy access to the switches enables the operator to operate the lights independently from the fan motor.